

f

n

f

m

f

x

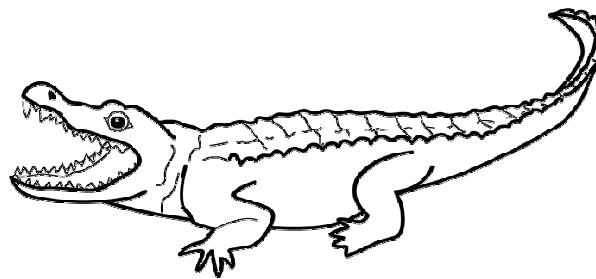
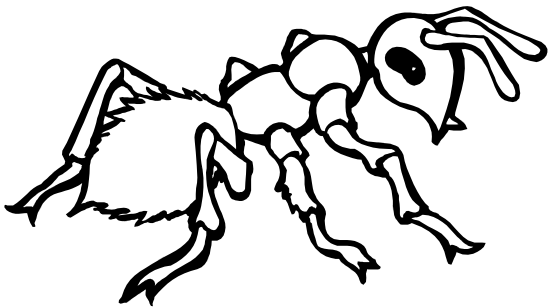
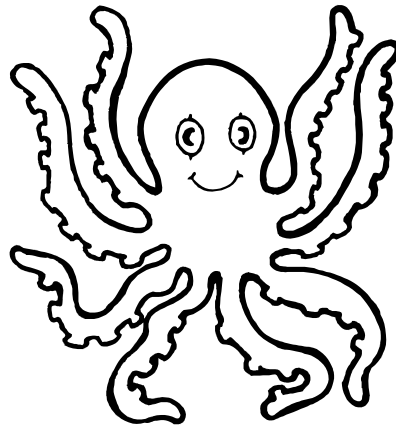
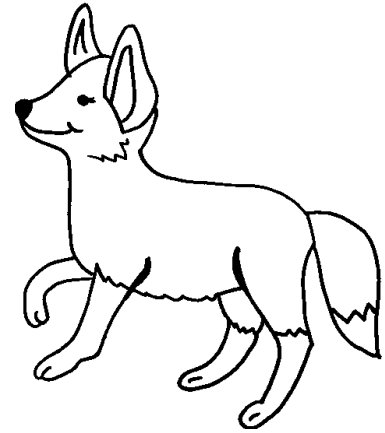
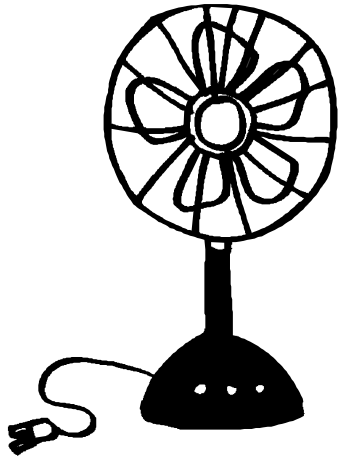

O

I

O

S

O

r

a

t

a

r

a

l

n

†

n

r

n

l

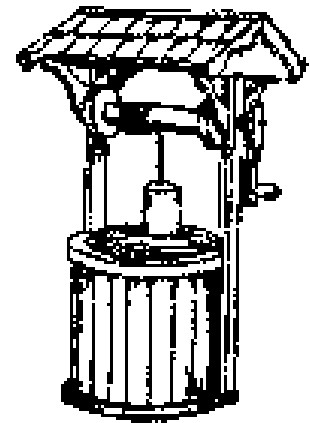
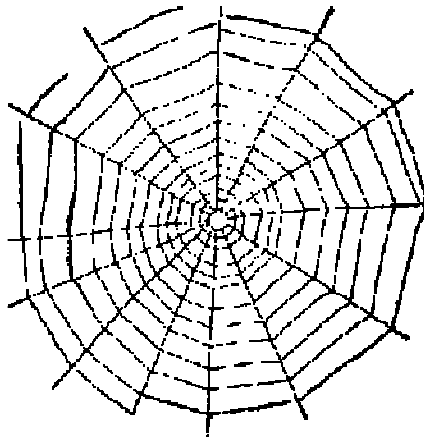
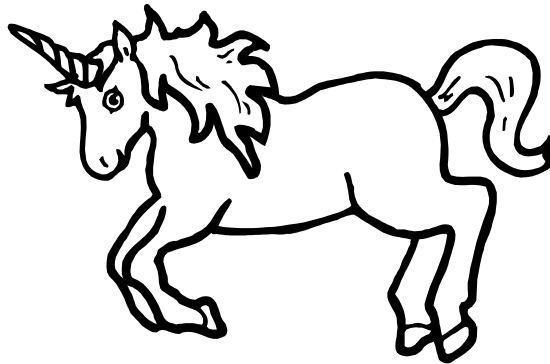
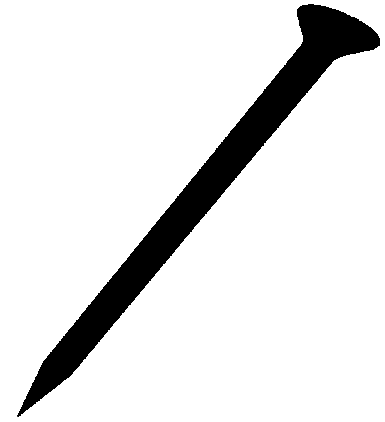
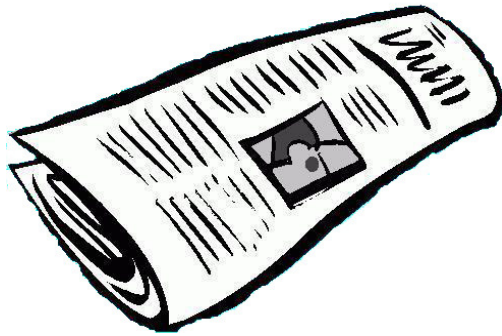
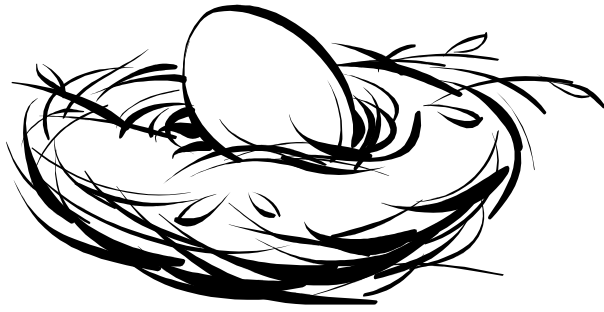

u

r

u

n

u

a

w

m

w

b

w

l

m

x

m

c

m

r

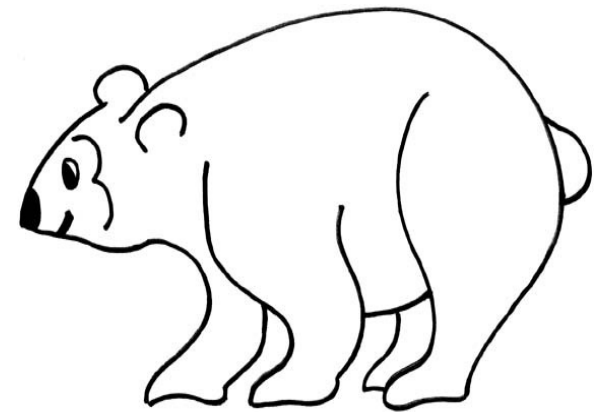
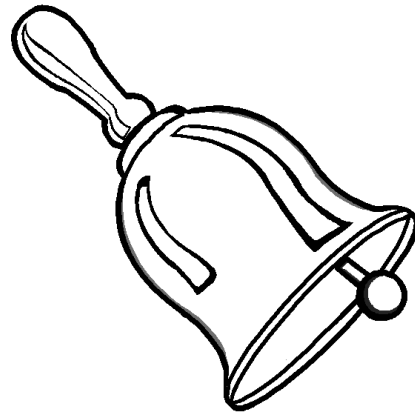
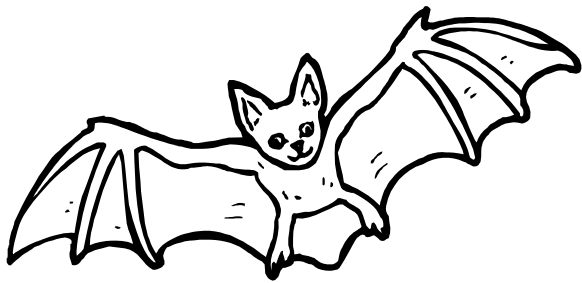
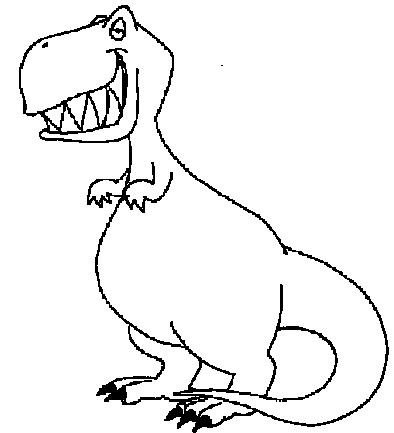
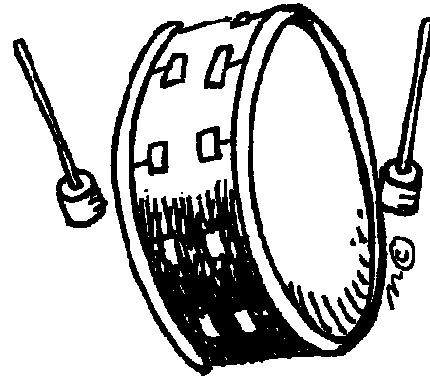
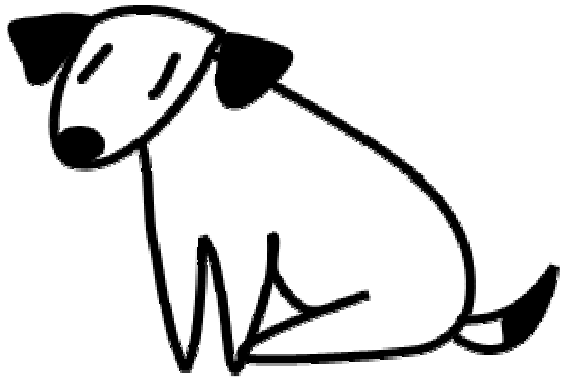
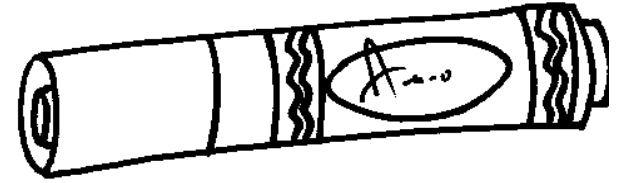
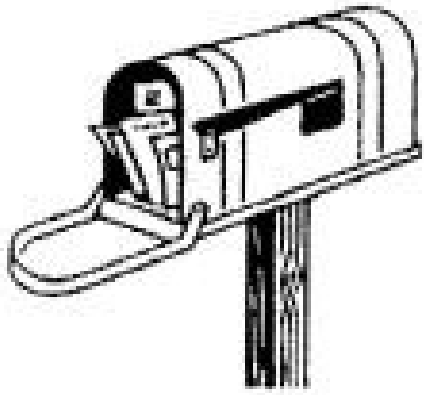

d

g

d

m

d

r

b

t

b

l

b

r

i

n

i

m

i

a

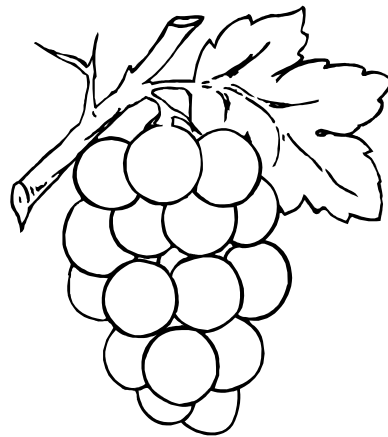
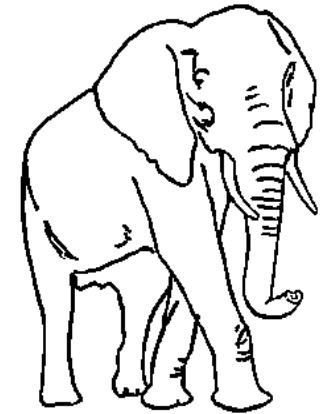
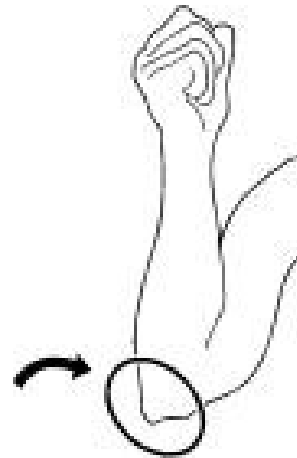
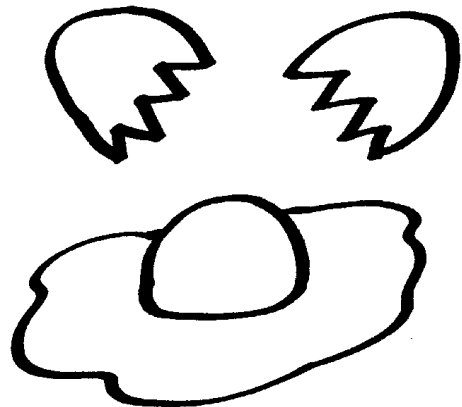
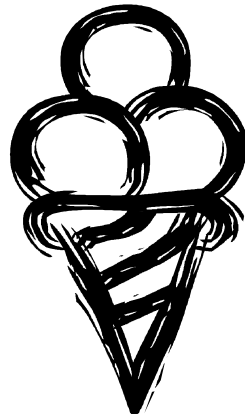
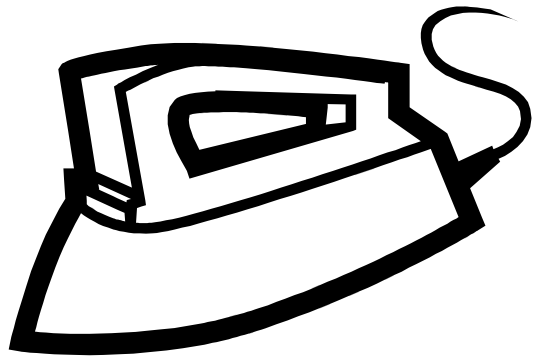

e

g

e

o

e

t

g

t

g

s

g

r

s

p

s

l

s

r

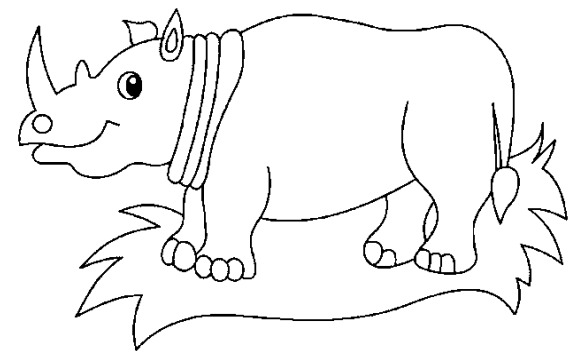
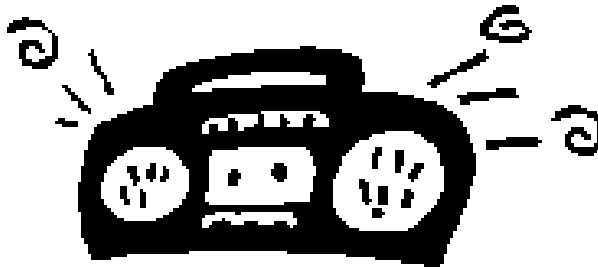
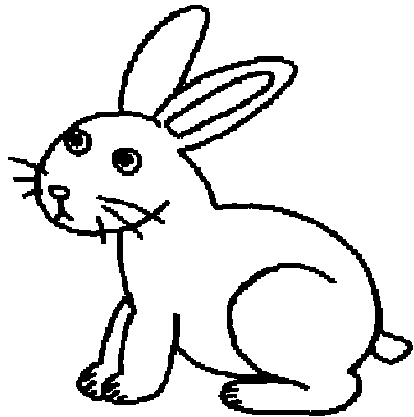
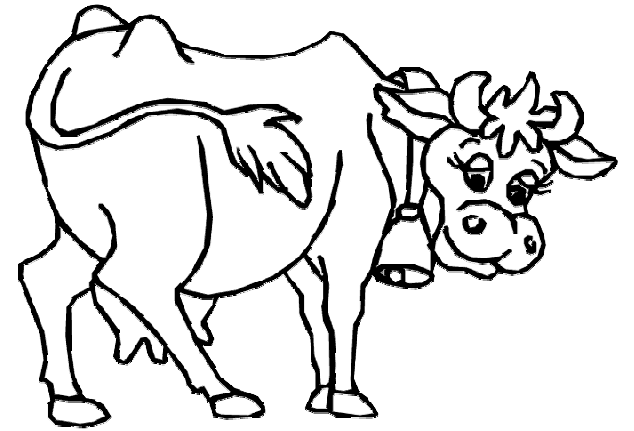
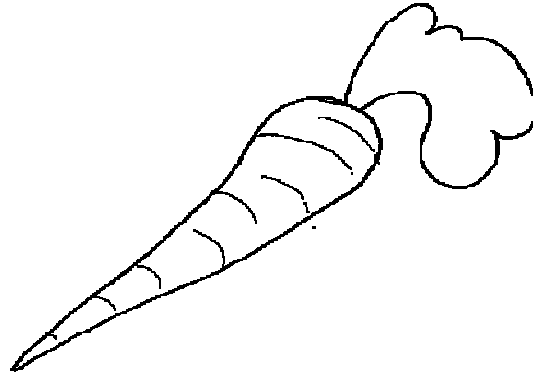
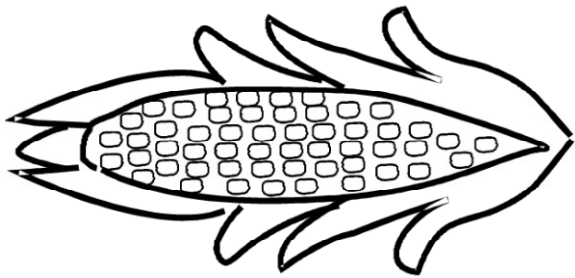
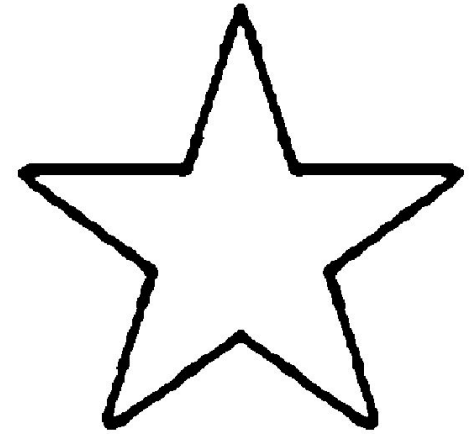

c

n

c

t

c

w

r

t

r

o

r

s

j

p

j

t

j

s

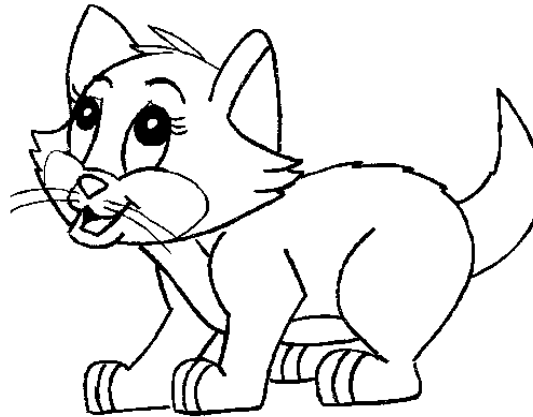
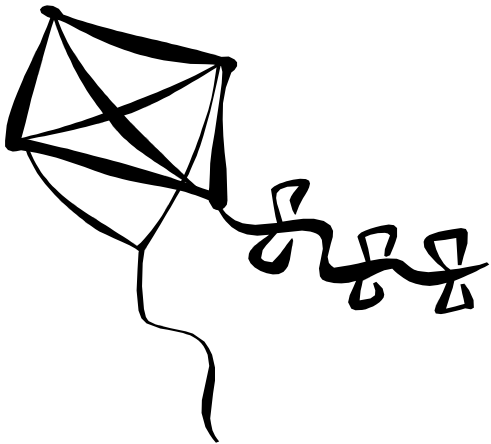
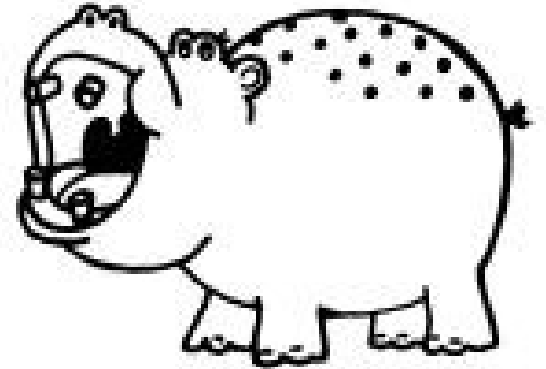
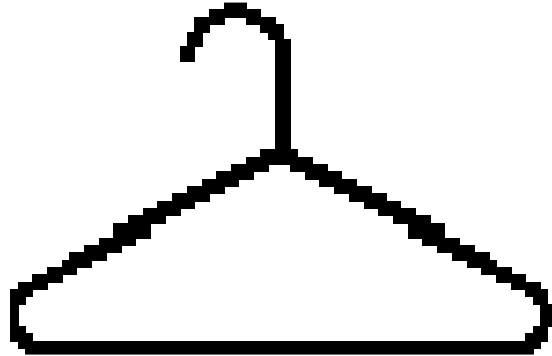
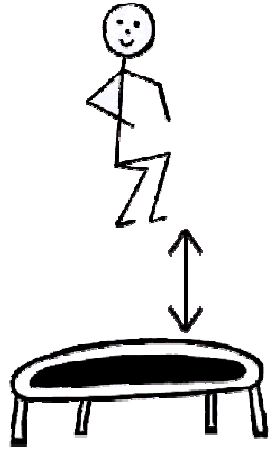

h

t

h

r

h

s

k

t

k

n

k

d

l

n

l

p

l

f

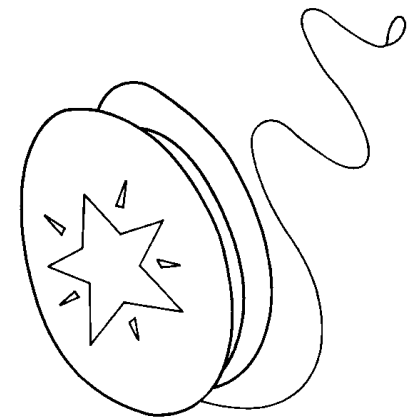
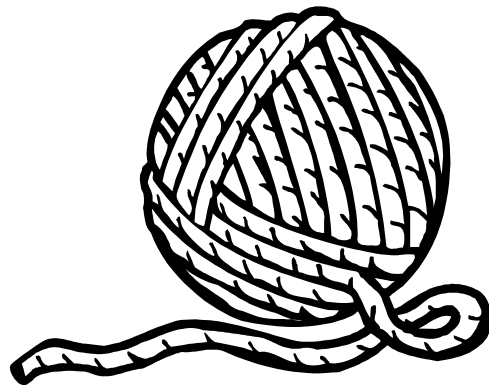
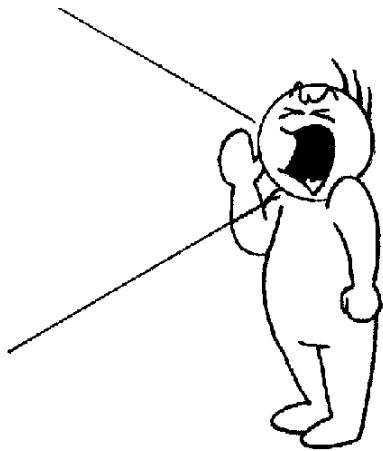
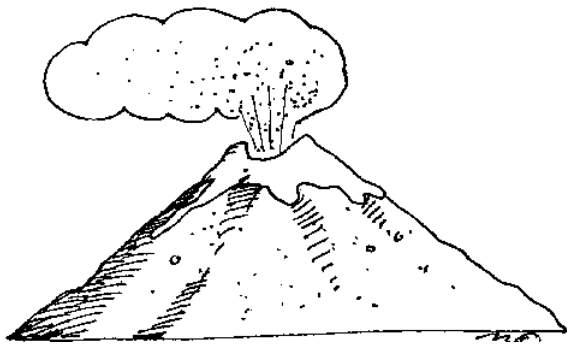
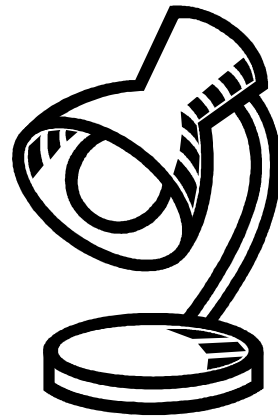

v

o

v

m

v

n

y

!

y

n

y

o

z

r

z

a

z

g

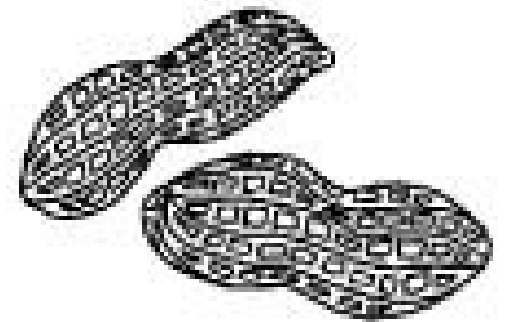
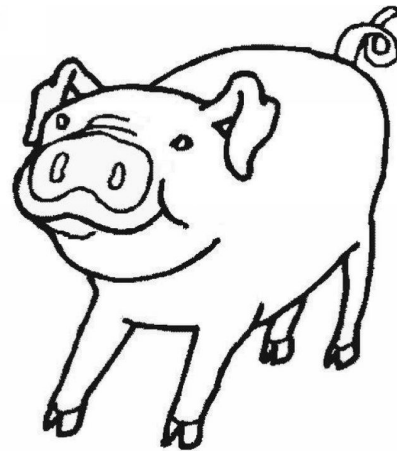
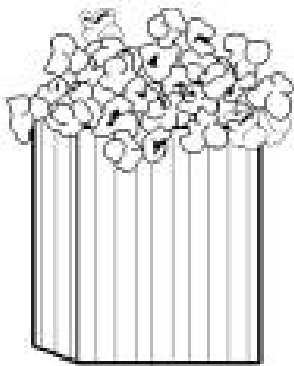
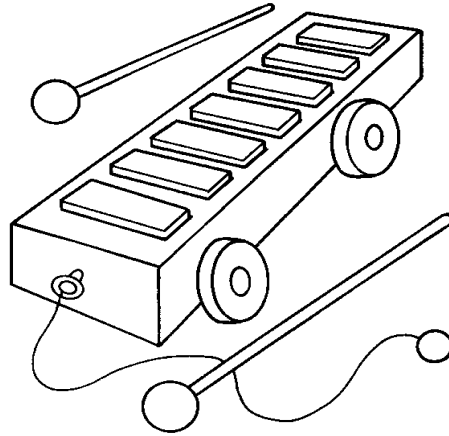
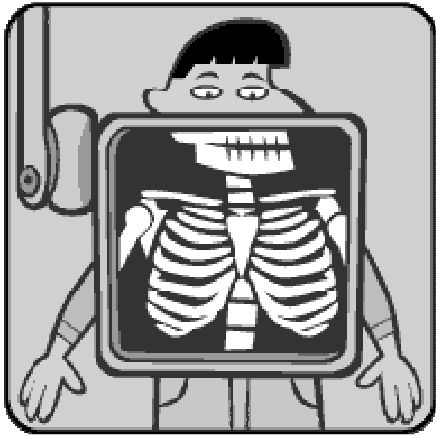
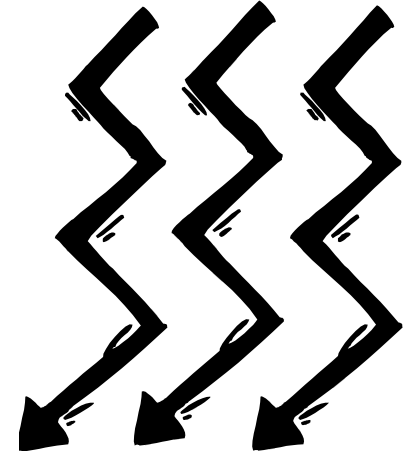
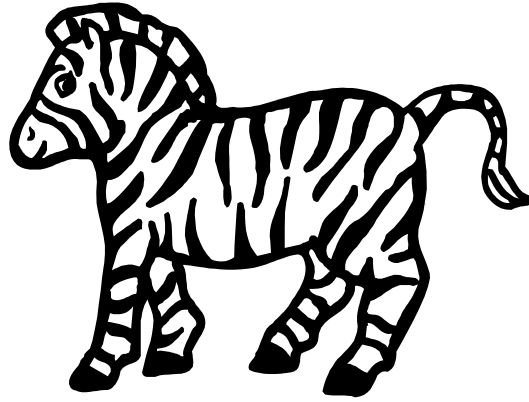
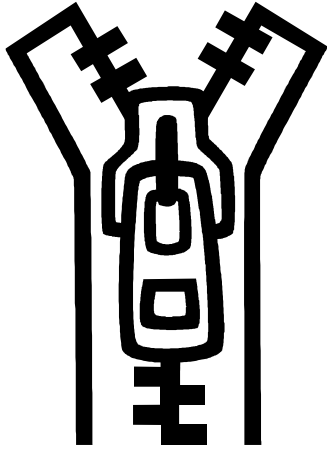

x

ay

x

n

x

n

p

n

p

g

p

s

qu

n

qu

t

qu

l

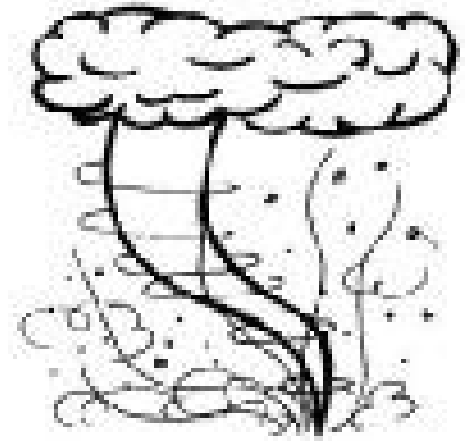
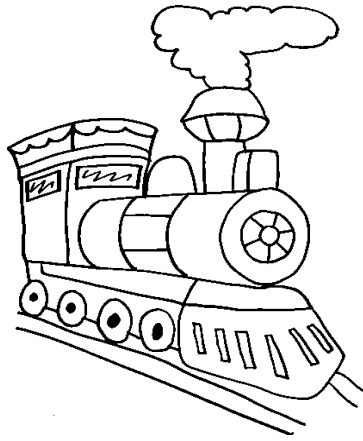
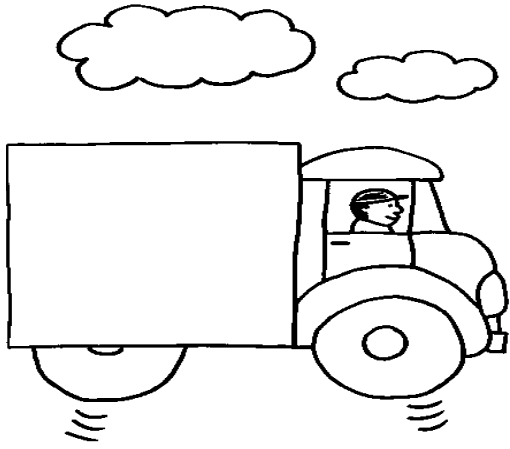
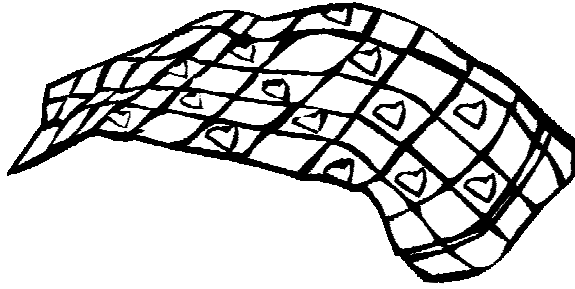
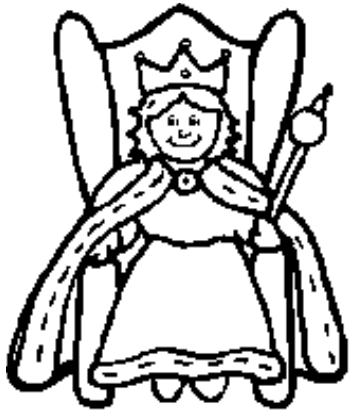

+

ck

+

n

+

o

